

## Automatic Film Applicator Standard (AB4120, AB4220, AB4320, AB4420)





# WARRANTY

TQC Sheen will grant a warranty for a period of 12 months for the Automatic Film Applicator Standard and 12 months for all related equipment from the date of delivery in respect of any evidence of faulty workmanship and materials.

Should a delivered consignment prove to be contrary to contract upon inspection, the customer shall grant TQC Sheen the opportunity hereunder of removing the fault, or else the customer may demand replacement. Because of size and weight of the instrument TQC Sheen will strive to give remote support.

Should the supply or delivery of any improvement or replacement not prove possible, the customer may choose between having the purchase price reduced or in demanding the contract of sale to be rescinded (conversion). Damage resulting from natural wear and tear, mechanical or chemical damage, an act of God or non compliance with the operating instructions shall be excluded from the warranty as well as mechanical interference by the customer or by third parties with Automatic Film Applicator Standard and related equipment without TQC Sheen's written permission. No liability will be accepted for defects, damage or injury caused due to use not carried out in accordance with the manufacturer's user instructions.

To claim warranty, the rejected product has to be sent to TQC Sheen together with the original invoice, any exchange before the product has been returned to TQC Sheen is not possible. TQC Sheen reserve the right to repair, exchange or supply an equivalent substitute. TQC Sheen is not liable for handling or transport costs. Warranty on the purchase price is limited, all liability for consequential damages or changes in technology is expelled.

This product complies to

- Machinery Directive 2006/42 / EC
- Low Voltage Directive 2006/95 / EC
- EMC Directive 2004/108 / EC



This product is RoHS 2 compliant (2011/65/EU)



# INDEX

<b>1</b>	<b>General</b>	<b>6</b>	<b>9</b>	<b>Instrument Setup</b>	<b>22/23</b>
1.1	Importance of operating manual		9.1	Instrument Setup Menu	
1.2	User-responsibility		9.2	Units	
1.3	Responsibility of personnel		9.3	Display Brightness	
1.4	Dangers		9.4	System Information	
1.5	Designated purpose		9.5	Reset	
1.6	Copyright				
1.7	Manufacturer's/Supplier's address		<b>10</b>	<b>Lifter Position</b>	<b>24</b>
<b>2</b>	<b>Safety Instructions</b>	<b>7</b>	<b>11</b>	<b>Installation of the Vacuum Bed</b>	<b>25/27</b>
2.1	Meaning of Symbols		11.1	Instructions	
2.2	Availability of Safety Information		11.2	Rubber Ring Placement	
2.3	Dangers from Electrical Energy		11.3	Test Chart Placement	
2.4	Modifications to the Equipment		11.4	Other Chart Sizes	
<b>3</b>	<b>Transport and Storage</b>	<b>8</b>	<b>12</b>	<b>Care and Maintenance</b>	<b>28</b>
3.1	Packing		<b>13</b>	<b>Disclaimer</b>	<b>29</b>
3.2	User: Check on Receipt				
3.3	Reporting Transport Damage and Documentation				
3.4	Storage and Protective Measures when not in use				
<b>4</b>	<b>Instrument Data</b>	<b>9/12</b>			
4.1	Name / Article				
4.2	Scope of Supply				
4.3	Technical Data				
4.4	Dimensions and Weight				
4.5	Basic Unit				
4.6	Accessories				
4.7	Spare Parts				
<b>5</b>	<b>Instrument Layout and Functions</b>	<b>13/14</b>			
5.1	Instrument Layout				
5.2	Connecting a Mouse and Keyboard				
<b>6</b>	<b>Instrument Preparations</b>	<b>15</b>			
6.1	Installation				
6.2	Placing the Bed				
6.3	Film Applicators				
6.4	Test Charts				
<b>7</b>	<b>Navigation</b>	<b>16</b>			
7.1	Menu				
7.2	Number Input				
7.3	Text Input				
<b>8</b>	<b>Care and Maintenance</b>	<b>17/21</b>			
8.1	Starting the Instrument				
8.2	Run				
8.3	Run Setup				
8.3.1	Manual				
8.3.2	Custom Presets				
8.3.3	New Custom Presets				
8.3.4	Standard Presets				
8.3.5	Set Positions				
8.3.6	Paper Clamp Mode				
8.3.7	Vacuum Mode				

# 1 GENERAL

## 1.1 Importance of operating manual

This manual is written in order to become familiar with all the functions and possible applications of the instrument. It contains important instructions about how to use the instrument safely and economically; according to the purpose designated. Following these instructions is not only essential to avoid risks. It also reduces repair costs and down-time and increases the products reliability and service-life.

Anyone who works with the instrument shall follow the instructions in this manual, particularly the safety related instructions. Additionally local rules and regulations relating to environmental safety and accident prevention should be observed. It is mandatory that users have read and understand this manual prior to first operation of the Automatic Film Applicator Standard.

## 1.2 User-responsibility

The user should

- a) Only allow persons to work with the instrument who are familiar with the general instructions on how to work safely and to prevent accidents. The use of the instrument should have been instructed duly.
- b) Regularly check the safety-awareness of personnel at work.

## 1.3 Responsibility of personnel

Before commencing work anyone appointed to work with the instrument should pay attention to the general regulations relating to working safety and accident prevention. The safety chapter and the warnings in this manual should have been read and understood; acknowledged as evidenced by their signature, as can be placed in the Operator qualification list Annex A.

## 1.4 Dangers

This instrument has been designed and constructed in accordance with state-of-the-art technology and the acknowledged safety regulations. Nevertheless, working with the instrument could cause danger to the life and health of the operator or to others, or damage to the instrument or other property. Therefore the instrument should only be used for its designated purpose, and in a perfect technical condition. Any defect that could have a negative effect on safety should be repaired and recorded.

## 1.5 Designated purpose

Automatic Film Applicator Standard is exclusively designed to apply thin films of liquid or pastes on test specimen. Other applications constitute improper use. TQC Sheen will not be held liable for damage resulting from improper use.

Designated purpose also includes properly observing all instructions in the operation manual, and adherence to inspection and maintenance schedules. TQC Sheen is entitled to request these form when warranty claims are made and during inspections to ensure safe operation and evaluate correct usage.

## 1.6 Copyright

The copyright of this operating manual remains with TQC Sheen. This operating manual is intended solely for the user and his personnel. Its instructions and guidelines may not be duplicated, circulated or otherwise passed on to others, neither fully, nor partly. Infringement of these restrictions may lead to legal action may be taken if this restrictions are infringed upon.

## 1.7 Manufacturer's/Supplier's address

Industrial Physics Inks & Coatings B.V.  
Molenbaan 19  
2908 LL Capelle aan den IJssel  
The Netherlands  
E-Mail: [info-ic@industrialphysics.com](mailto:info-ic@industrialphysics.com)  
T +31 (0)10 7900 100  
F +31 (0)10 7900 129

# 2 SAFETY INSTRUCTIONS

## 2.1 Meaning of Symbols

The following symbols for dangers are used in this instruction manual.



**Possible immediate danger to the life or health of personnel.**

If this guideline is not noted it can lead to severe danger to health, up to fatal injury.



**A dangerous situation could be caused.**

Non observance of this guideline can lead to injury or to damage to equipment.



**Special tips and particular information.**

Guidelines to make optimal use of the instrument.

## 2.2 Availability of Safety Information

The instruction manual should be kept in proximity to where the instrument operates and should be visible and accessible at any time of operation.

In addition to the information contained in the instruction manual, general and local regulations for accident prevention and environmental protection shall be kept available and observed. Always ensure all guidelines in respect of safety and dangers on the instrument are in readable condition.

In case of danger the instrument has to be switched off by means of the on / off switch at the left back side of the instrument or by unplugging the mains power, then the danger should be eliminated.

## 2.3 Dangers from Electrical Energy

- Work on the electrical supply may only be done by a qualified electrician.
- The electrical equipment of the instrument must be checked regularly. Loose connections and cables damaged by heat must be corrected immediately.
- Always make sure the instrument's power is turned off while adjusting any electrical component.



***Make sure that no paint or other liquids are spilled on the electronics***

## 2.4 Modifications to the Equipment

- Any modifications or additions or alterations to the instrument may solely be made with permission from the manufacturer otherwise the warranty will be void.
- Instruments which are not in fault-free condition must immediately be switched off
- Only use replacement parts from the original supplier. Parts used from other sources aren't guaranteed to take the loading and meet the safety requirements.

## 3 TRANSPORT AND STORAGE

### 3.1 Packing

- Please take note of pictorial symbols on the packing.
- Check for transport damages. If the packaging is damaged only accept it with a written approval of the transporter that the package was damaged.

### 3.2 User: Check on Receipt

- Check packing for damage
- After unpacking check complete supply.

### 3.3 Reporting Transport Damage and Documentation

- Any damage should be documented as accurately as possible (possibly photographed) and reported to the relevant insurers or, in the case of sales "delivered to customers works", to the supplier.

### 3.4 Storage and Protective Measures when not in use

- The instrument must be stored in a dry place at a temperature between 10 - 40°C / 50 - 104°F.
- If packing is damaged upon receipt immediately inform the forwarder and make a note on the packing list and have it signed by the forwarder. Ideally make some pictures of the damage as well.
- Store instrument in the original packing if possible.



# 4 INSTRUMENT DATA

## 4.1 Name / Article

<b>AB4120</b>	Automatic Film Applicator Standard (Glass)
<b>AB4220</b>	Automatic Film Applicator Standard (Perforated vacuum)
<b>AB4320</b>	Automatic Film Applicator Standard (Double channel vacuum)
<b>AB4420</b>	Automatic Film Applicator Standard (Combined, without bed)







## 4.2 Scope of Supply

### Standard supplied

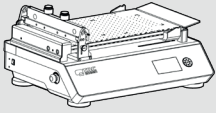
### Only supplied with AB4120

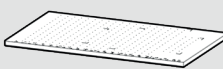
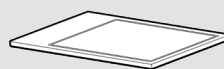
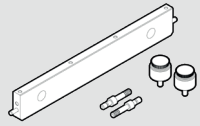
### Only supplied with AB4220

### Only supplied with AB4320

 TQC Sheen Automatic Film Applicator Standard	 24V Adapter + Power Cable	 Glass Bed	 Perforated Vacuum Bed	 Double Channel Vacuum Bed
 Weight + Extra Weights + Screws	 Manual	 Rubber Mat	 Set of Rubber Rings	 Rubber Ring

## 4.3 Technical Data

Traverse speed:	0.1 - 500 mm/s / 0.004 – 19.7 in/s
Traverse speed accuracy:	+/- 1% of set speed
Stroke length:	50 - 430 mm / 1.97 – 16.93 in
Stroke length accuracy:	+/- 2 mm / +/- 0.08 in
Max. test chart size:	515 x 300 mm / 20.28 x 11.81 in
Max. test chart thickness:	9 mm / 0.35 in
Max. thickness of test substrate:	35 mm / 1.38 in incl. coating
Max. vacuum area:	DIN A3 / Scrub
Automatic vacuum areas:	DIN A5, DIN A4, DIN A3, Scrub
Diameter vacuum holes:	1,4 mm / 0.06 inch
Distance between vacuum holes:	19 mm / 0.75 inch horizontal, 20 mm / 0.79 inch vertical
Number of vacuum holes:	A5: 8 (h) x 9 (v) = 72 A4: 11 (h) x 13 (v) = 143 A3: 15 (h) x 21 (v) = 315 Scrub: 9 (h) x 24 (v) = 216
Active vacuum area:	A5: 153 x 180 mm / 6 x 7.1 inch A4: 210 x 260 mm / 8.3 x 10.2 inch A3: 286 x 420 mm / 11.3 x 16.5 inch Scrub: 172 x 480 mm / 6.8 x 18.9 inch
Wire bar spiral area:	max. 325 mm / max. 12.8 in
Min. Wire bar length:	345 mm / 13.58 in
Max. Wire bar diameter:	10 mm / 0.39 in at fixation points
Width alternative applicators:	max. 300 mm / max. 11.81 in
Height alternative applicators:	10 -80 mm / 0.39 - 3.15 in

## 4.4 Dimensions and Weight

Depth:	490 mm / 19.29 in
Width:	640 mm / 25.2 in
Height:	290 mm / 11.42 in
Weight:	30 - 35 kg depending on model

## 4.5 Basic Unit

Power supply:	24 V DC / 100-240 W, 50-60 Hz
Power consumption:	max. 50 W
Display:	480 x 272 pixel TFT display
Controls:	5-button navigation Mouse keyboard (optional)

## 4.6 Accessories

### Tools

**AB3500** Drying time recorder tool

**AB3090** Scratch hardnesspen tool

**AB3075** Grindometer tool

### Add-ons

**AB4600** Block Applicator Weight

**AB4005** Spiral bar (ø12.7 mm /0.5 inch) adapter

### Film Applicators type "BAKER" 4-sided

**VF2145** Baker film applicator width 60 mm, gaps 15/30/60/90 µm

**VF2146** Baker film applicator width 60 mm, gaps 30/60/90/120 µm

**VF2147** Baker film applicator width 60 mm, gaps 50/100/150/200 µm

**VF1510** Baker film applicator width 60 mm, 4 gaps as desired

**VF1500** Baker film applicator width 80 mm, gaps 15/30/60/90 µm

**VF1501** Baker film applicator width 80 mm, gaps 30/60/90/120 µm

**VF1502** Baker film applicator width 80 mm, gaps 50/100/150/200 µm

**VF1515** Baker film applicator width 80 mm, 4 gaps as desired

**VF1560** Baker film applicator width 80 mm, gaps 2 x 90µm 2 x 150µm

**VF1521** Baker film applicator width 100 mm, gaps 15/30/60/90 µm

**VF1522** Baker film applicator width 100 mm, gaps 30/60/90/120 µm

**VF1523** Baker film applicator width 100 mm, gaps 50/100/150/200 µm

**VF1520** Baker film applicator width 100 mm, 4 gaps as desired

**VF1526** Baker film applicator width 150 mm, gaps 15/30/60/90 µm

**VF1527** Baker film applicator width 150 mm, gaps 30/60/90/120 µm

**VF1528** Baker film applicator width 150 mm, gaps 50/100/150/200 µm

**VF1525** Baker film applicator width 150 mm, 4 gaps as desired

**VF1529** Baker film applicator \*special\* film width between 151-200mm

**VF1531** Baker film applicator \*special\* film width between 201-250mm

### Film Applicators type "BIRD" 4-sided

**VF2161** Bird film applicator width 50 mm, gaps 50/100/150/200 µm

**VF1837** Bird film applicator width 50 mm, 4 gaps as desired

**VF2164** Bird film applicator width 60mm, 4 gaps as desired

**VF2162** Bird film applicator width 75 mm, gaps 50/100/150/200 µm

**VF1530** Bird film applicator width 75 mm, 4 gaps as desired

**VF1536** Bird film applicator width 80 mm, 4 gaps as desired

**VF2163** Bird film applicator width 100 mm, gaps 50/100/150/200 µm

**VF1535** Bird film applicator width 100 mm, 4 gaps as desired

**VF1581** Bird film applicator width 150 mm, gaps 50/100/150/200µm

**VF1580** Bird film applicator width 150 mm, 4 gaps as desired

**VF1582** Bird filmapplicator \*Special\* film width between 151-200mm

**VF1583** Bird filmapplicator \*Special\* film width between 201-250mm

### Film Applicators type "BIRD" 1-side

**VF1540** Bird film applicator 50mm, 1 gap as desired

**VF1541** Bird film applicator 50mm, 1 gap 50µm

**VF1542** Bird film applicator 50mm, 1 gap 75µm

**VF1543** Bird film applicator 50mm, 1 gap 100µm

**VF1544** Bird film applicator 50mm, 1 gap 125µm

**VF1545** Bird film applicator 50mm, 1 gap 150µm

**VF1546** Bird film applicator 50mm, 1 gap 200µm

**VF1570** Bird film applicator 75mm, 1 gap as desired

**VF1571** Bird film applicator 75mm, 1 gap 50µm

**VF1572** Bird film applicator 75mm, 1 gap 75µm

**VF1573** Bird film applicator 75mm, 1 gap 100µm

<b>VF1574</b>	Bird film applicator 75mm, 1 gap 125µm
<b>VF1575</b>	Bird film applicator 75mm, 1 gap 150µm
<b>VF1576</b>	Bird film applicator 75mm, 1 gap 200µm
<i>Film Applicators type "BIRD" with guidance</i>	
<b>VF1586</b>	Bird Applicator 90mm with guidance, 25µm
<b>VF1587</b>	Bird Applicator 90mm with guidance, 50µm
<b>VF1588</b>	Bird Applicator 90mm with guidance, 75µm
<b>VF1589</b>	Bird Applicator 90mm with guidance, 100µm
<b>VF1591</b>	Bird Applicator 90mm with guidance, 150µm
<b>VF1592</b>	Bird Applicator 90mm with guidance, 200µm
<b>VF1593</b>	Bird Applicator 90mm with guidance, 250µm
<b>VF1595</b>	Bird Applicator 90mm with guidance, gap as desired
<i>Film Applicators type "Quadruplex" 4-sided</i>	
<b>VF2167</b>	Quadruplex film applicator width 60 mm, 4 gaps as desired
<b>VF2168</b>	Quadruplex film applicator width 60 mm, gaps 15/30/60/90 µm
<b>VF2169</b>	Quadruplex film applicator width 60 mm, gaps 30/60/90/120 µm
<b>VF2170</b>	Quadruplex film applicator width 60 mm, gaps 50/100/150/200 µm
<b>VF2172</b>	Quadruplex film applicator width 80 mm, 4 gaps as desired
<b>VF2173</b>	Quadruplex film applicator width 80 mm, gaps 15/30/60/90 µm
<b>VF2174</b>	Quadruplex film applicator width 80 mm, gaps 30/60/90/120 µm
<b>VF2175</b>	Quadruplex film applicator width 80 mm, gaps 50/100/150/200 µm
<b>VF2179</b>	Quadruplex DUAL film applicator width 2x 60 mm, gaps 100/200/300/400 µm
<i>Film Applicator type "Octoplex" 8-sided</i>	
<b>VF1550</b>	Octoplex film applicator, width 60mm, with 8 gaps: 25/50/75/100/125/150/175/200 µm
<i>Levelling / Sagging Applicator</i>	
<b>VF2246</b>	Levelling/Sagging Test Applicator Type VA 1 (SAG Tester) for both tests 75-300µm
<b>VF2247</b>	Levelling/Sagging Test Applicator Type VA 1 (SAG Tester) for both tests 250-475µm
<i>Sag Index Applicators</i>	
<b>VF2250</b>	Sag Index Applicator 50 till 275µm
<b>VF2251</b>	Sag Index Applicator 250 till 475µm
<b>VF2252</b>	Applicator 450 till 675µm
<i>Wire Bar Coater 320 mm width, without hand-grip</i>	
<b>AB3050</b>	Wire Bar Coater 320 mm, 4 µm
<b>AB3051</b>	Wire Bar Coater 320 mm, 6 µm
<b>AB3052</b>	Wire Bar Coater 320 mm, 8 µm
<b>AB3053</b>	Wire Bar Coater 320 mm, 10 µm
<b>AB3054</b>	Wire Bar Coater 320 mm, 12 µm
<b>AB3055</b>	Wire Bar Coater 320 mm, 14 µm
<b>AB3056</b>	Wire Bar Coater 320 mm, 16 µm
<b>AB3057</b>	Wire Bar Coater 320 mm, 20 µm
<b>AB3058</b>	Wire Bar Coater 320 mm, 24 µm
<b>AB3059</b>	Wire Bar Coater 320 mm, 30 µm
<b>AB3060</b>	Wire Bar Coater 320 mm, 34 µm
<b>AB3061</b>	Wire Bar Coater 320 mm, 38 µm
<b>AB3062</b>	Wire Bar Coater 320 mm, 40 µm
<b>AB3063</b>	Wire Bar Coater 320 mm, 50 µm
<b>AB3064</b>	Wire Bar Coater 320 mm, 56 µm
<b>AB3065</b>	Wire Bar Coater 320 mm, 60 µm
<b>AB3066</b>	Wire Bar Coater 320 mm, 76 µm
<b>AB3067</b>	Wire Bar Coater 320 mm, 100 µm
<b>AB3068</b>	Wire Bar Coater 320 mm, 120 µm
<b>AB3069</b>	Wire Bar Coater 320 mm, 200 µm
<b>AB3070</b>	Wire Bar Coater 320 mm, plain polished
<b>AB3071</b>	Wire Bar Coater 320 mm, microns as desired

#### Test charts

<b>VF2343</b>	Test charts A6, White/Black B+, with optical brightner, 250pcs
<b>VF2344</b>	Test charts A5, White/Black B+, with optical brightner, 250pcs
<b>VF2345</b>	Test charts A4, White/Black B+, with optical brightner, 250pcs
<b>VF2346</b>	Test charts A5, Black/White chequered B+, with optical brightner, 250pcs
<b>VF2347</b>	Test charts A4, Black/White chequered B+, with optical brightner, 250pcs
<b>VF2354</b>	Test charts A3, Black/White chequered B+, with optical brightner, 250pcs
<b>VF2317</b>	Test charts A6, White/Black B-, without optical brightner, 250pcs
<b>VF2319</b>	Test charts A5, White/Black B-, without optical brightner, 250pcs
<b>VF2321</b>	Test charts A4, White/Black B-, without optical brightner, 250pcs
<b>VF2323</b>	Test charts A5, Black/White chequered B-, without optical brightner, 250pcs
<b>VF2325</b>	Test charts A4, Black/White chequered B-, without optical brightner, 250pcs
<b>VF2316</b>	Washability opacity scrub charts, 100 stuks

#### 4.7 Spare Parts

<b>AB4000</b>	SBR rubber place mat, 70 shore A
<b>AB4130</b>	Glass Bed
<b>AB4200</b>	Perforated vacuum bed
<b>AB4205</b>	Perforated vacuum bed (Stainless steel)
<b>AB4300</b>	Double channel vacuum bed
<b>AB4305</b>	Double channel vacuum bed (Stainless steel)

# 5 INSTRUMENT LAYOUT AND FUNCTIONS

## 5.1 Instrument Layout

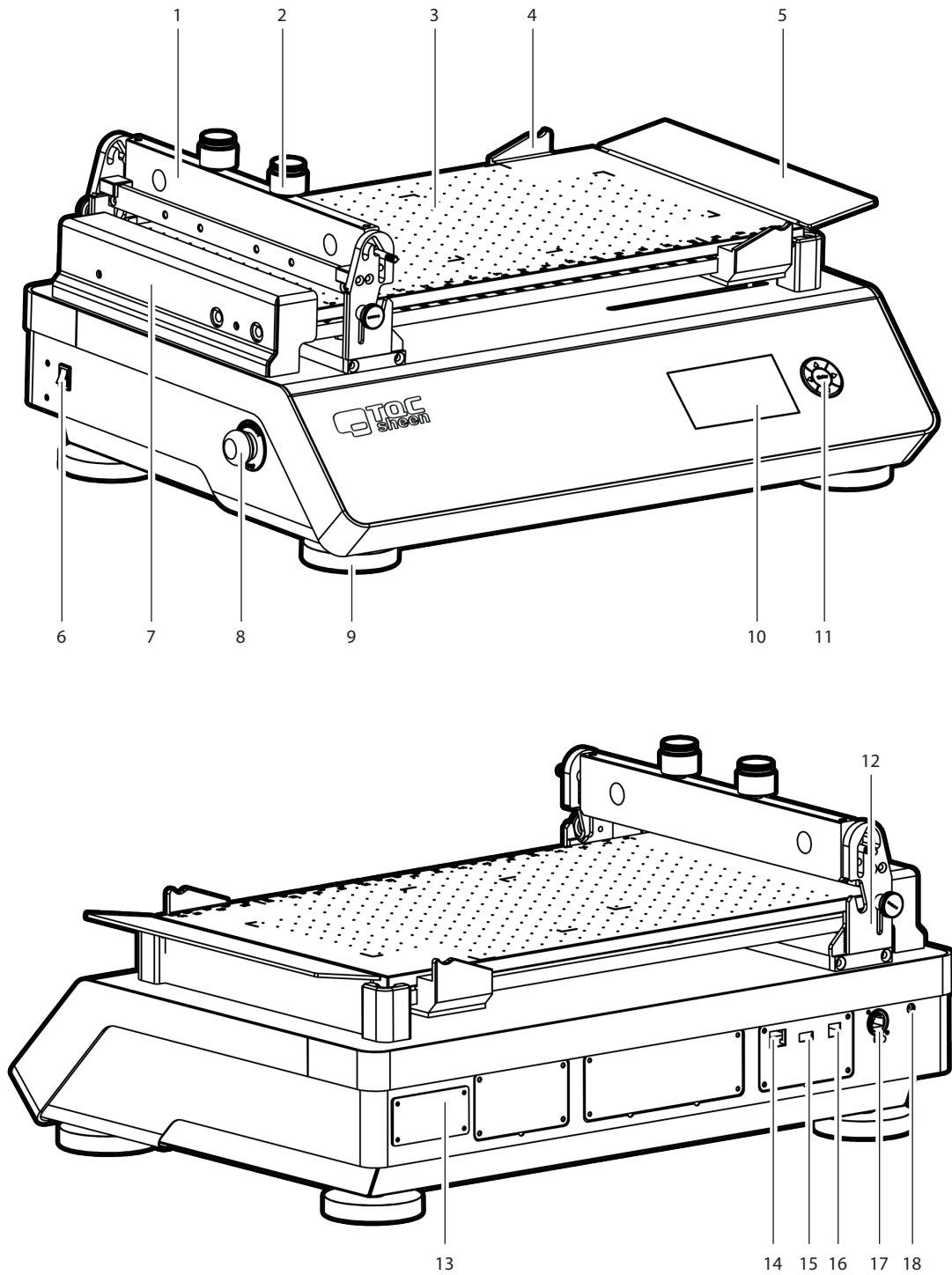

- |  |   |                            |                  |
|--|---|----------------------------|------------------|
| 1 Wire Bar Weight  | 5 Splash Shield                         | 9 Adjustable Feet          | 14 Ethernet      |
| 2 Optional Weight  | 6 Power Switch                          | 10 Full Color Display      | 15 USB-A         |
| 3 Perforated Vacuum Bed,<br>Double Channel Vacuum Bed or Glass Bed | 7 Paper Clamp<br>(with Glass Bed Model) | 11 5-key Navigation Switch | 16 USB-B         |
| 4 Lifter   | 8 Emergency Button                      | 12 Tool Carrier            | 17 TQC Sheen Bus |
|  |   | 13 Machine ID-tag          | 18 Power Entry   |

## 5.2 Connecting a Mouse and Keyboard



- ① The instrument can also be controlled by a mouse and/or keyboard.

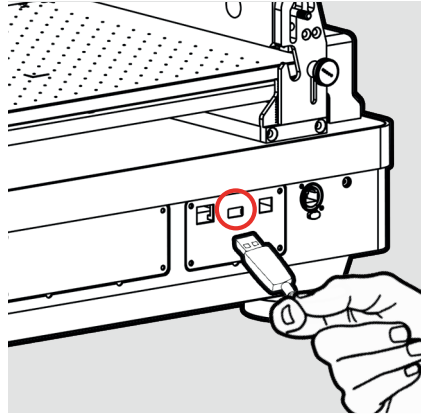

- ② Connect the mouse and/or keyboard to the USB-A port at the back of the instrument.

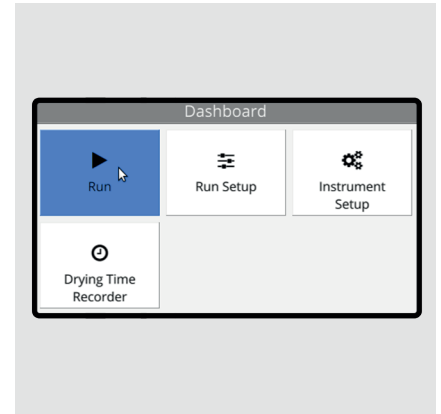

- ② Clicking the left mouse button behaves the same as the OK button. (Not all input fields can be controlled by a mouse.)

# 6 INSTRUMENT PREPARATIONS

## 6.1 Installation

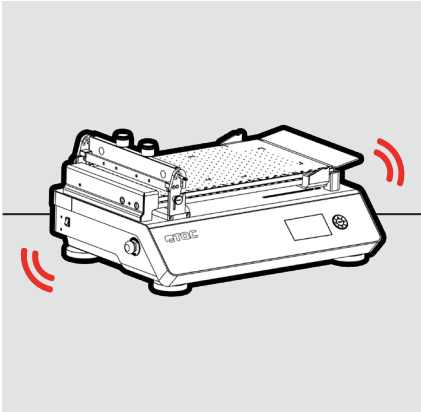

① The instrument has to be installed on a sturdy table or work area.

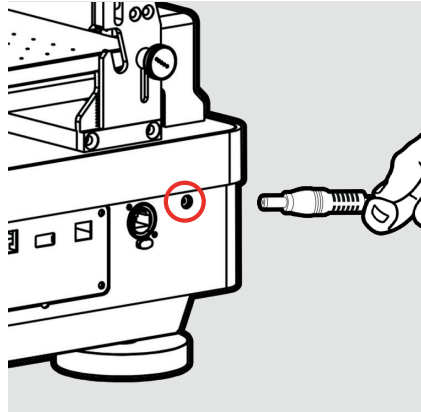

② Connect the power cable to the machine and a wall socket.

## 6.2 Placing the Bed

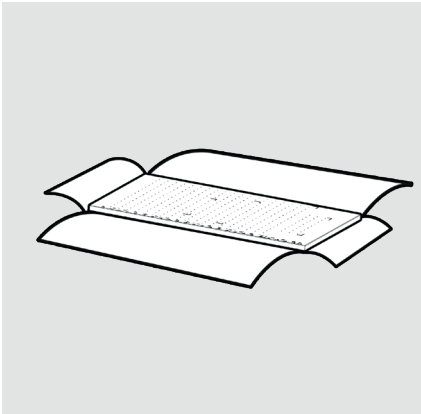

① Unpack the glass or vacuum bed. Make sure all tape is removed.

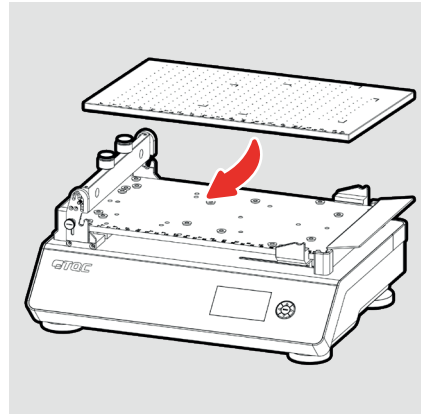

② Place the glass or vacuum bed on the instrument. See chapter 11 for more information about the configurable vacuum areas.

## 6.3 Film Applicators

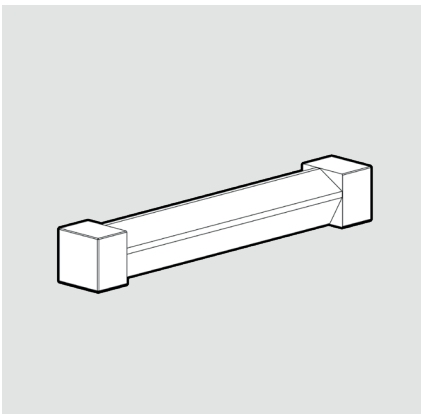

A wide range of film applicators can be used, more details on film applicators can be found in chapter 4.3.

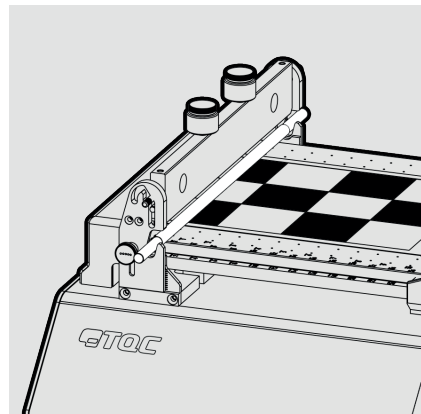

Placing Wire bar applicators. The max. dimensions of the wound area is 355 mm length,  $\varnothing$  8mm or 10 mm. For  $\varnothing$ 12.7mm / 0.5 inch spiral applicators Art. No. AB4005 is required.

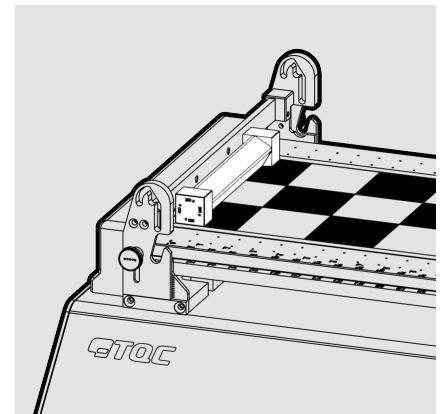

Placing other applicators.

## 6.4 Test charts

TQC Sheen supplies a range of test charts (TQC Sheen, Leneta® or equivalent) like: Opacity(hiding power charts), Opacity Display charts, SAG and levelling charts, Brush out charts, Plain White charts, Washability Scrub charts or others.

# 7 NAVIGATION

## 7.1 Menu

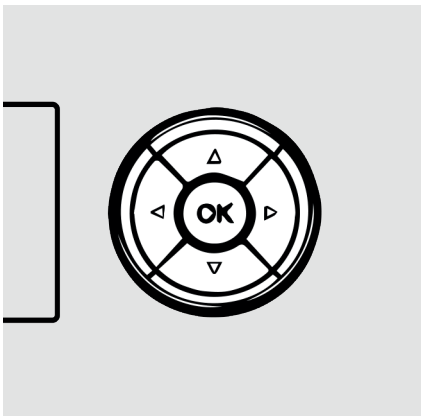

① Use the 5-key button to navigate through the interface. Red lights in the 5-key button indicate possible actions for the selected button. A mouse or keyboard can be used to control the instrument.

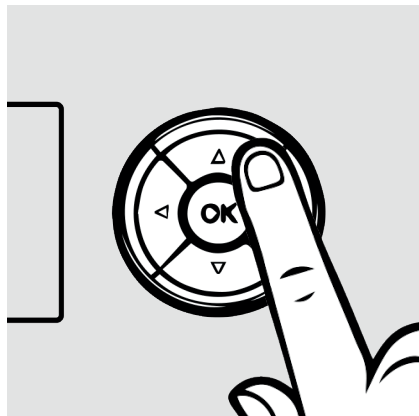

② You can change the selected button by pressing the arrows on the 5-key button.

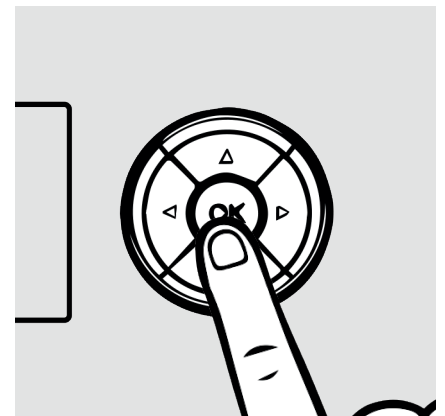

③ To confirm the selected button, press **OK** on the 5-key button.

## 7.2 Number Input

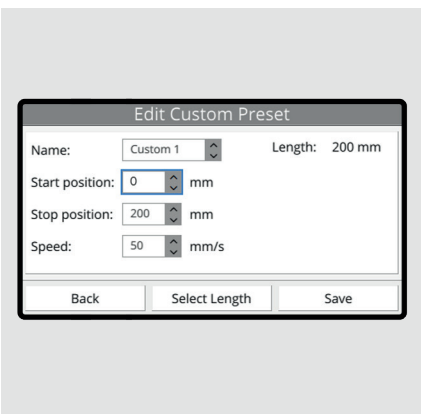

① Select the input and press **OK** to edit the value.



② Use the ▲ and ▼ buttons to increase or decrease the value.

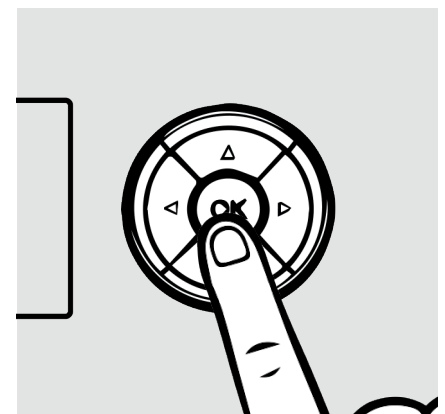

③ Press **OK** to stop editing.

## 7.3 Text Input

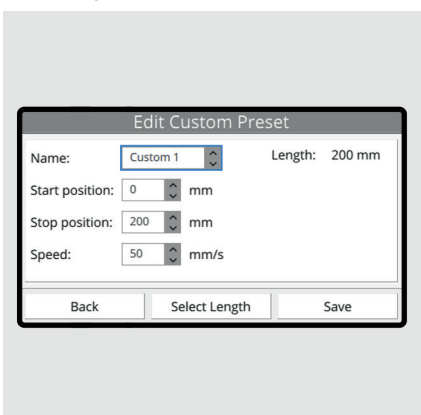

① Select the input and press **OK** to edit the value.

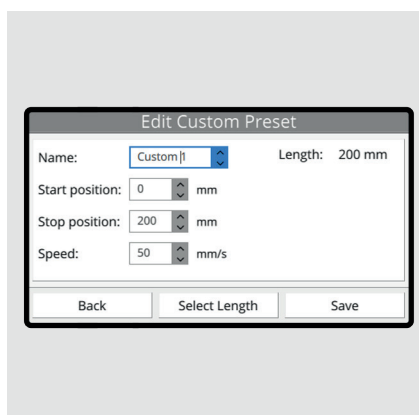

② Use the ◀ and ▶ buttons to select the character.

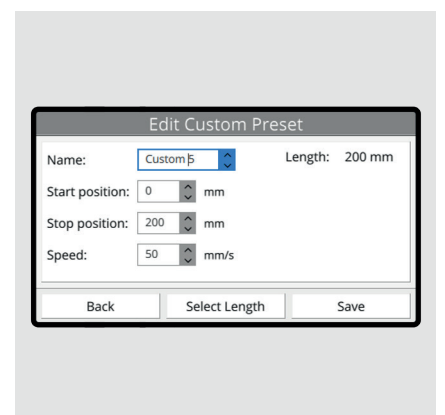

③ Use the ▲ and ▼ buttons to change the character.



# 8 OPERATION

## 8.1 Starting the Instrument



① This screen will be displayed after turning on the instrument.

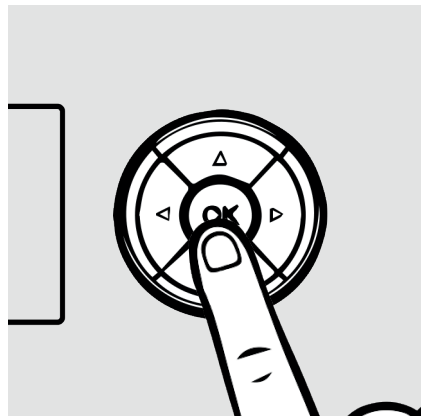

② Press **OK** to initialize the instrument.

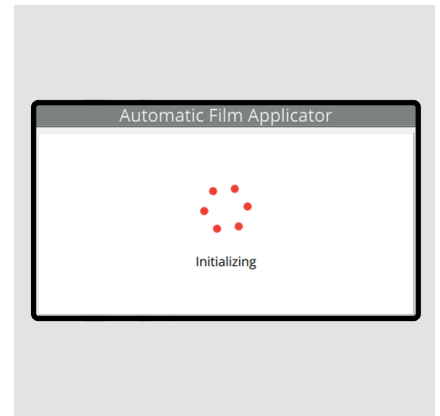

③ The instrument will check the system for any errors and the Tool Carrier will be calibrated.

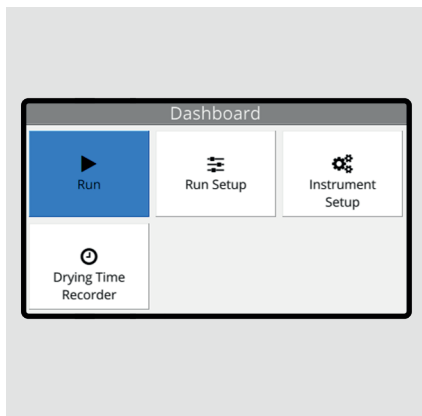

**Run**  
Start a test with current set run setup.

**Run Setup**  
Configure the run setup.

**Instrument Setup**  
Configure instrument settings.

**Drying Time Recorder**  
Enter the Drying Time Recorder tool menu.  
A separate manual is delivered with the Drying Time Recorder Tool.

## 8.2 Run

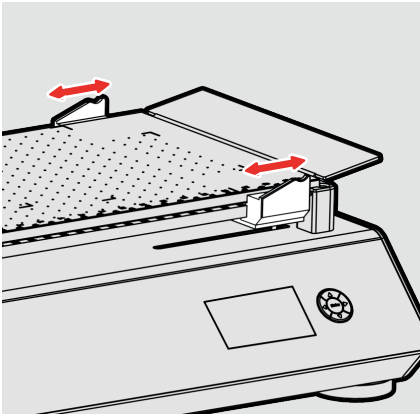

- ① If Autoreturn is enabled, set the Lifter in the right position. See chapter 10.

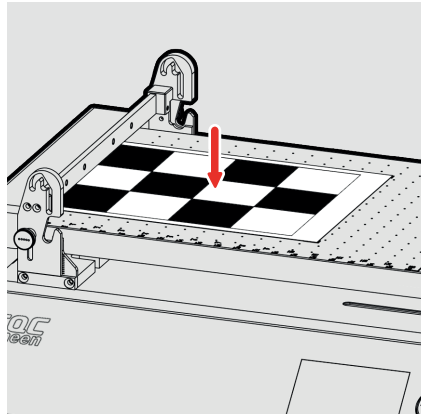

- ② Place the test chart on the bed. See chapter 11.3.



- ③ Follow the instructions on the display.

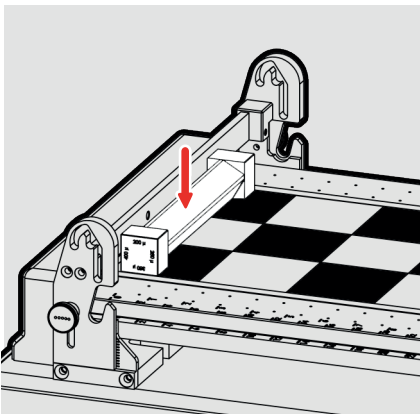

- ④ Place the applicator on the test chart and apply the paint.

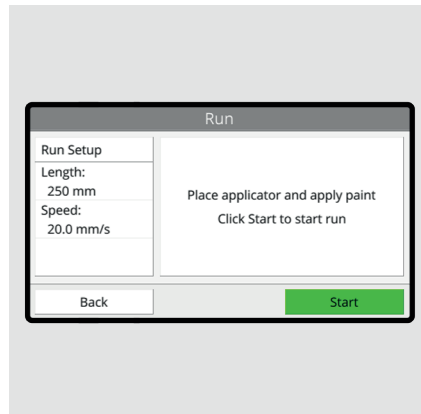

- ⑤ Follow the instructions on the display.

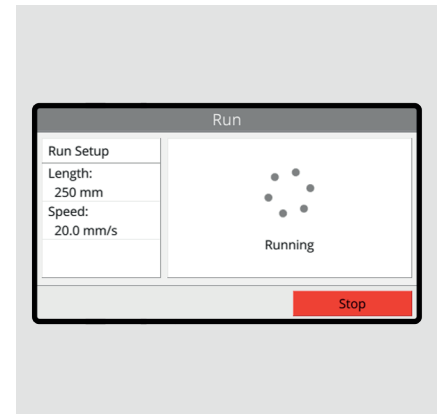

- ⑥ The tool carrier will move towards the set stop position. Click **Stop** to abort the run.

**Warning! Moving parts.**

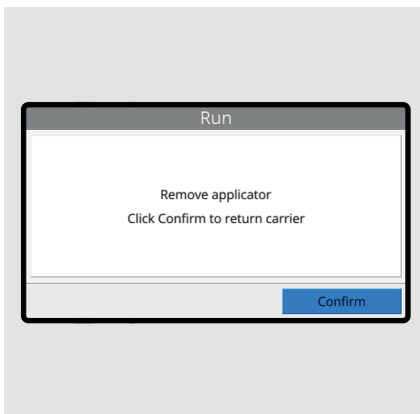

- ⑦ Click **Confirm** to return the tool carrier to its start position. This screen will only appear when Autoreturn is disabled.

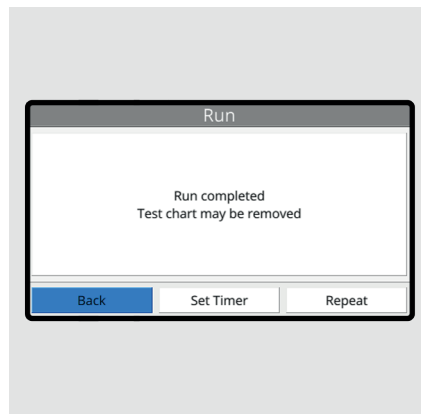

- ⑧ Click **Back** to return to the Dashboard. Click **Set Timer** to configure a timer. Click **Repeat** to start a new Run.

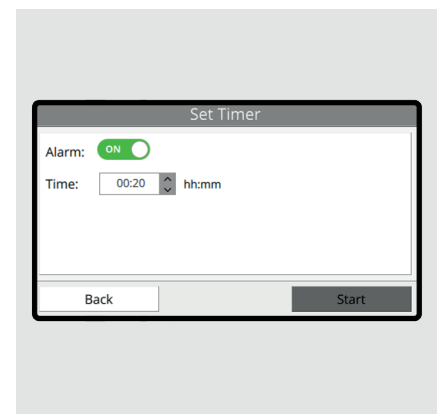

- ⑨ An alarm can be set after a Run. For example, if the film has to dry for a specific time before being removed.

### 8.3 Run Setup

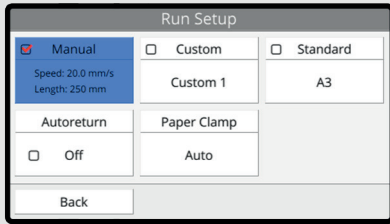

- 1 Length and speed for a run are set in Manual, Custom or Standard. The red checkmark indicates the active setup.

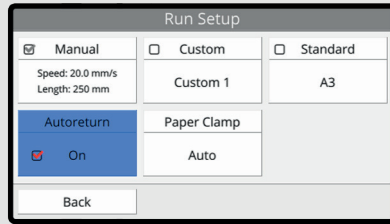

- 2 Click the **Autoreturn** button to enable or disable Autoreturn.

#### 8.3.1 Manual

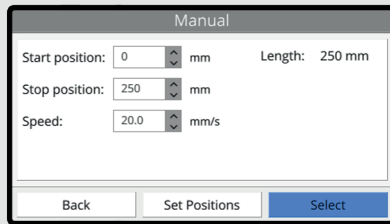

- 1 Set the start position, stop position, and speed. Click **Select** to use the manual setup.

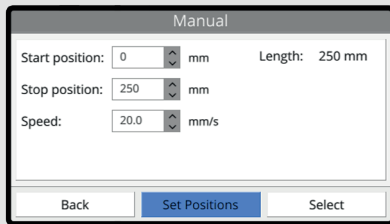

- 2 If uncertain about the start position and stop position, use **Set Positions** to determine the positions.

#### 8.3.2 Custom Presets

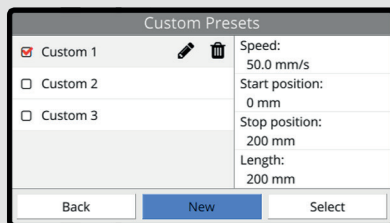

- 1 Click **New** to create a new custom preset. Click to edit the selected preset. Click to delete the selected preset.

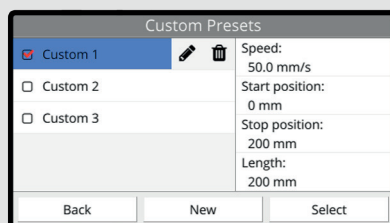

- 2 The selected preset settings are listed on the right.

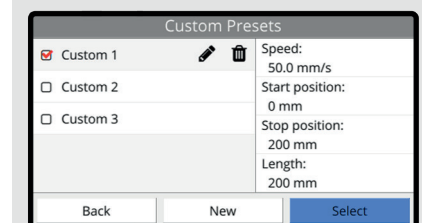

- 3 Click **Select** to use the selected custom preset.

### 8.3.3 New Custom Preset

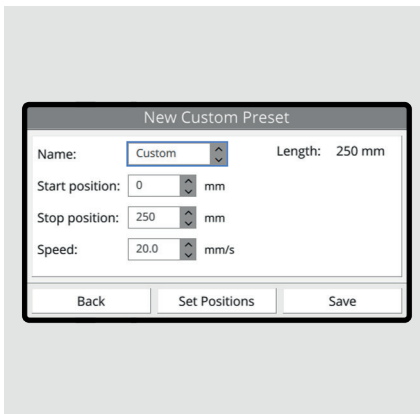

① Similar to Manual, set the start position, stop position, and speed. A name can be given to the custom preset.

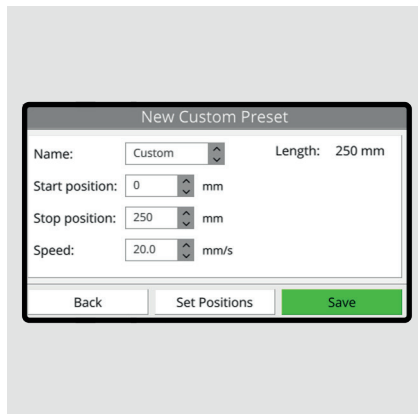

② Click **Save** to save the new custom preset. The new preset will be listed in the Custom Preset menu.

### 8.3.4 Standard Presets

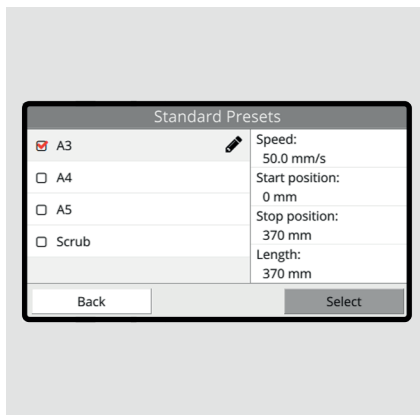

① Predefined preset for default paper sizes. A4, A3 and scrub can be used with the lifter. See chapter 10.

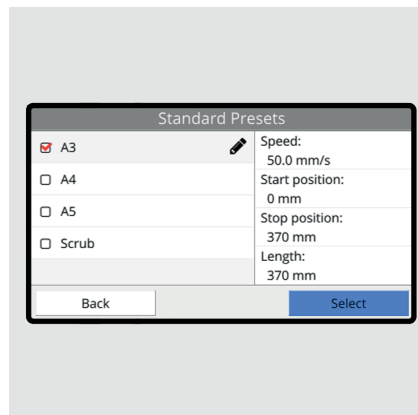

② Click **Select** to use the selected standard preset.

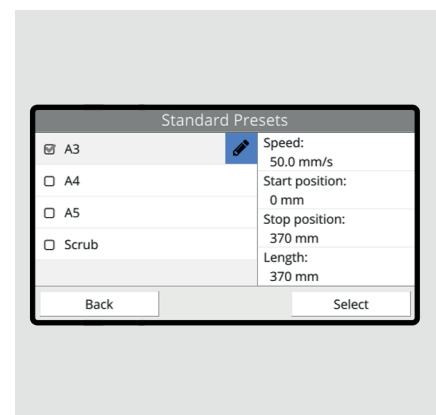

③ Click to edit speed.

### 8.3.5 Set Positions

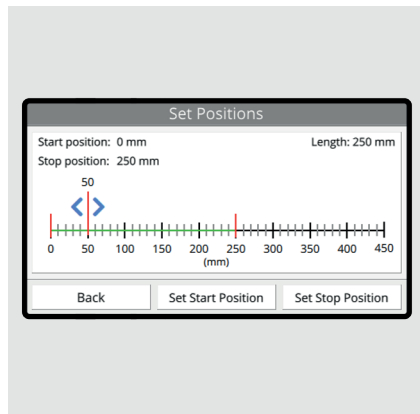

① Move the tool carrier by using the ◀ and ▶ buttons.

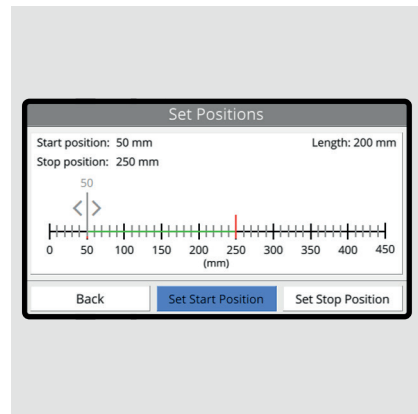

② Click **Set Start Position** to set the current position as start position.

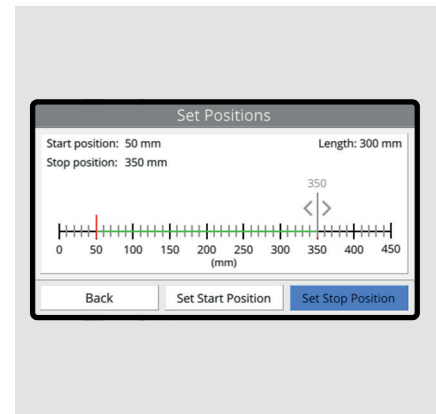

③ Click **Set Stop Position** to set the current position as stop position.

### 8.3.6 Paper Clamp Mode (Only with AB4120)

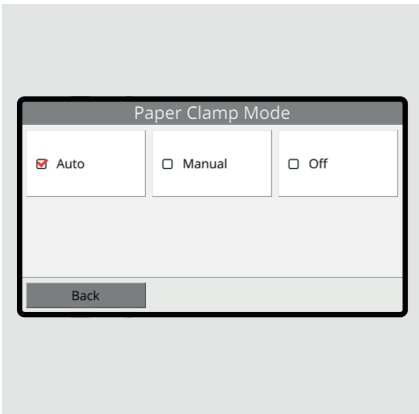

#### Auto

The paper clamp will close automatically after the test chart has been placed.

#### Manual

The paper clamp has to be closed and opened during run preparations.

#### Off

The paper clamp will not close during a run.

### 8.3.7 Vacuum Mode (Only with AB4220/AB4320)

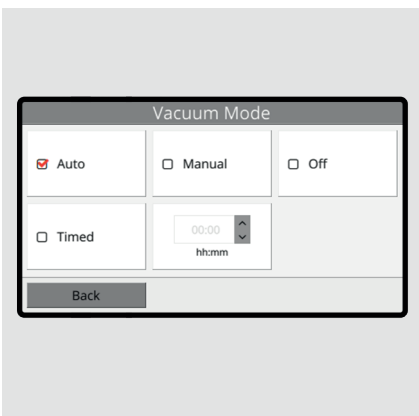

#### Auto

The vacuum pump will start automatically after the test chart has been placed.

#### Manual

The vacuum pump to be started and stopped during run preparations.

#### Off

The vacuum pump will not start during a run.

#### Timed

The vacuum pump will start automatically after the test chart has been placed. When a run is completed the vacuum pump will stay on until the set time has been reached.

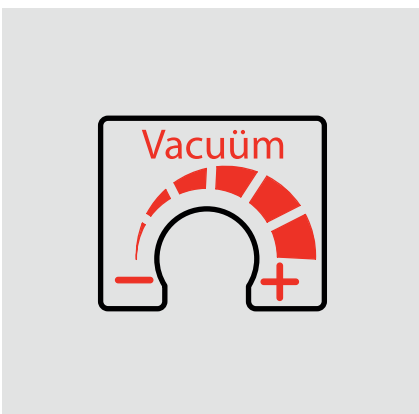

#### Vacuum regulation

This is a factory setting. If you want to change the setting, please contact your supplier. (The vacuum regulation is not on the AB4120.)

# 9 INSTRUMENT SETUP

## 9.1 Instrument Setup Menu

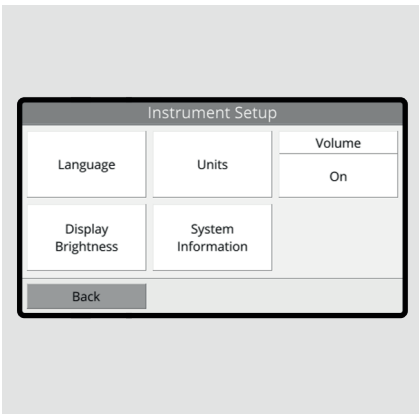

① This menu contains all instrument related settings and information about the system.



② Select the desired language and click **Back** to change the systems language.

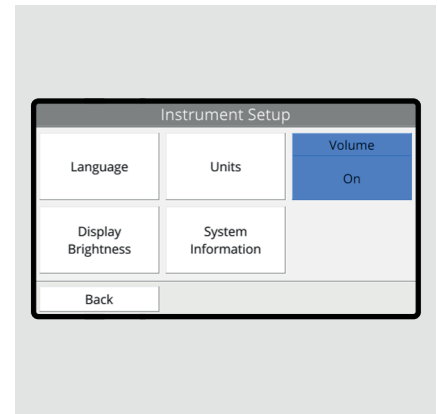

③ Click the **Volume** button to enable or disable alarm sounds.

## 9.2 Units

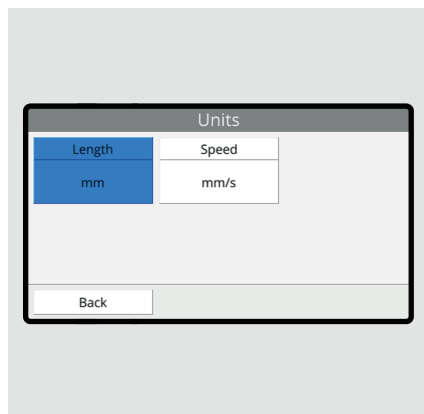

① Click **Length** to set the length unit. Options are: Millimeter, Centimeter or Inch.



② Click **Speed** to set the speed unit. Options are: Millimeter per second, Centimeter per second or Inch per second.

## 9.3 Display Brightness

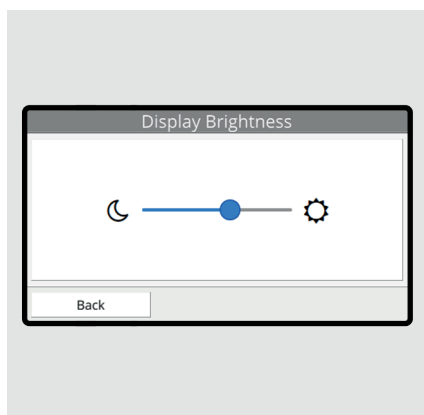

① Use the ◀ and ▶ buttons to change the brightness level of the display.

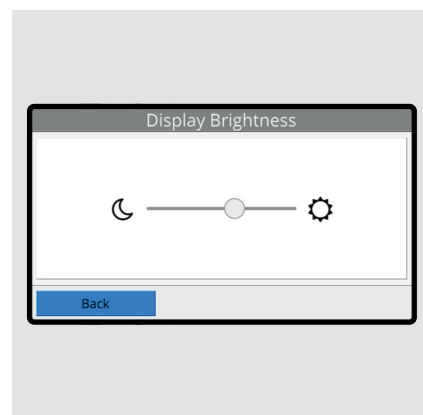

② Click **Back** to save the brightness level.

## 9.4 System Information

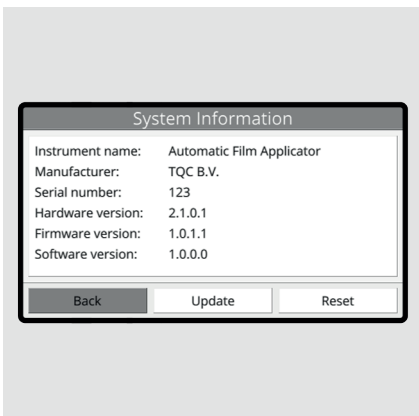

- 1 Information about the instrument is listed here. When requesting support, always provide the serial number and the versions. (Versions may be different than listed here.)

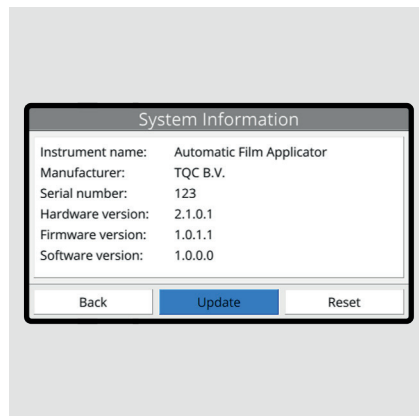

- 2 Information about updating the system will be given when an update is released.

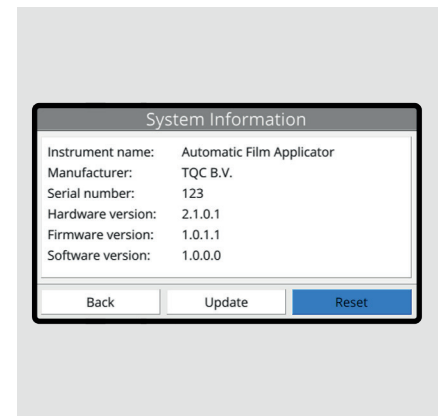

- 3 Click **Reset** to reset presets.

## 9.5 Reset

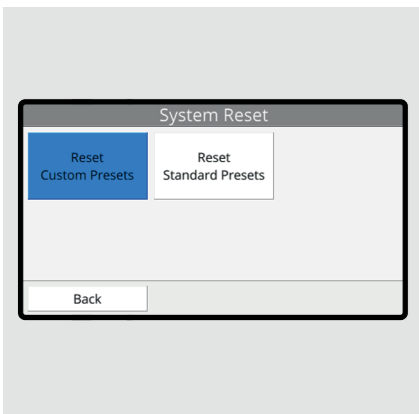

- 1 Click **Reset Custom Presets** to remove all custom presets.

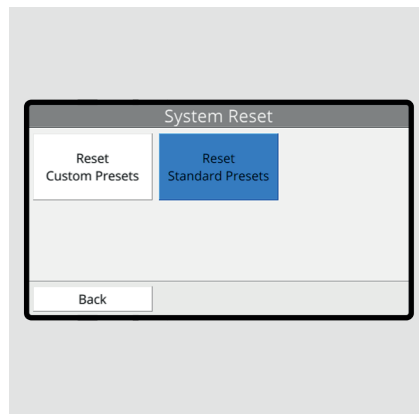

- 2 Click **Reset Standard Presets** to set the standard presets to their default values.



 **Warning: this action cannot be reversed. Saved presets will be lost.**

## 10 LIFTER POSITION

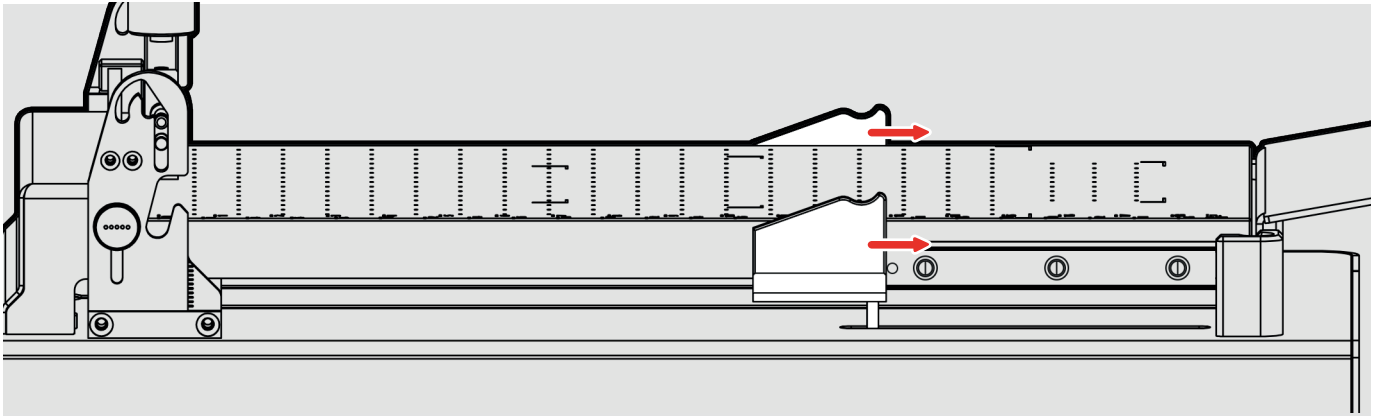
A4 – A3 – Scrub



The Lifter is used to retain Wire bar applicators after performing a run. The Lifter can be used with the following test chart sizes: A4, A3, and Scrub (Select the corresponding Preset, see chapter 8.3.4). The lifter needs to be manually moved towards the correct position.

-  ***When not using the standard A4, A3 or Scrub presets, set the Lifter in Scrub position.***
-  ***When using a Wire bar applicator and a custom length is set, make sure to disable Autoreturn.***



# 11 INSTALLATION OF THE VACUUM BED

## 11.1 Instructions

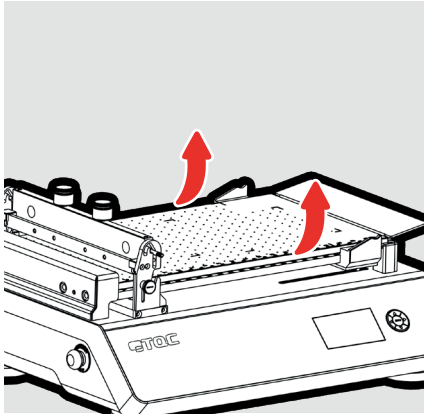

① Remove the vacuum bed from the base bed and stow it in a safe place.

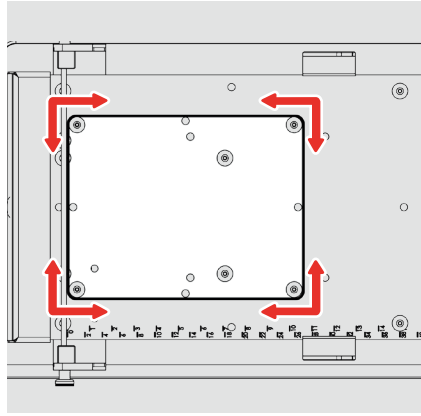

② Place the corresponding rubber ring. See chapter 11.2.

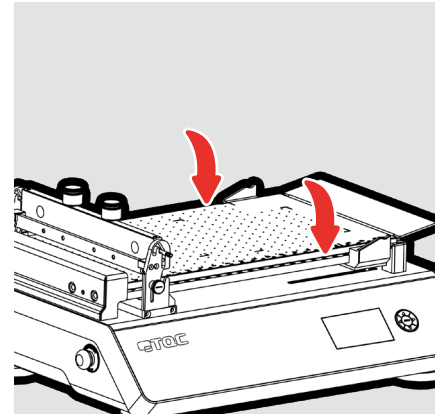

③ Place the vacuum bed gently back on the base bed. Make sure not to displace the rubber ring.

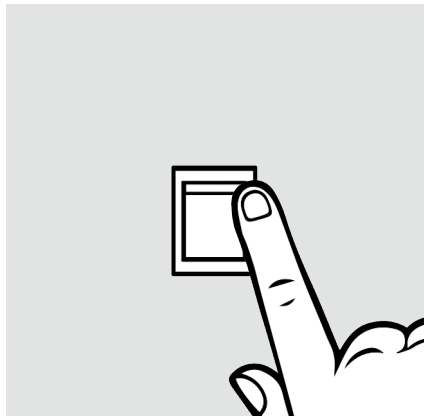

④ Turn on the instrument and follow steps 1-3 from the Run instructions. See chapter 8.2. See chapter 11.3 for instructions on placing the test chart correctly on the vacuum bed.

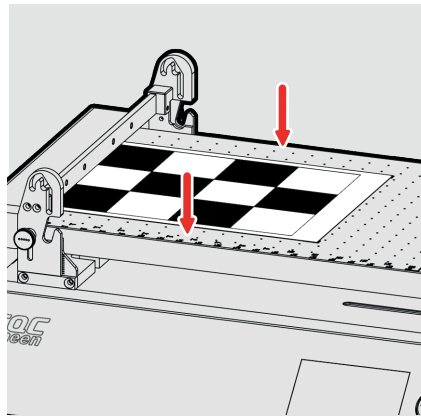

⑤ The test chart should be sucked to the vacuum bed. If not, grab the sides of the base bed and the vacuum bed and press them together.

**i** *When the pitch of the vacuum pump changes and sounds softer, the vacuum seal is complete.*

### 11.2 Rubber Ring Placement

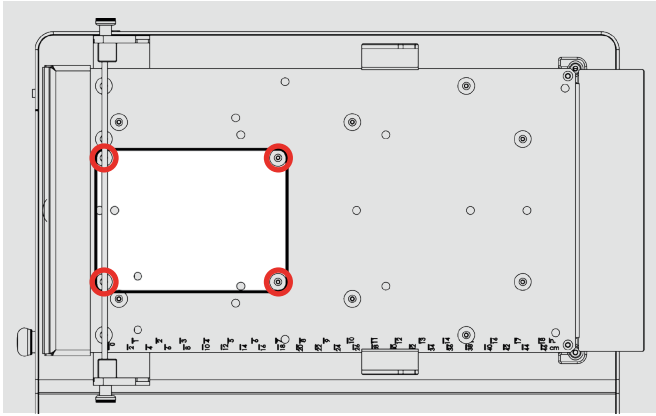

A5

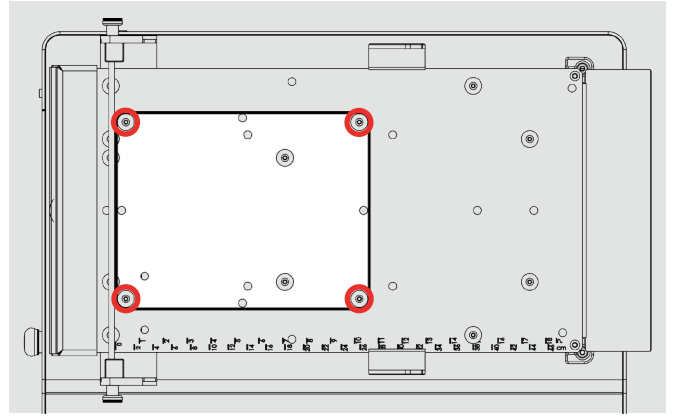

A4

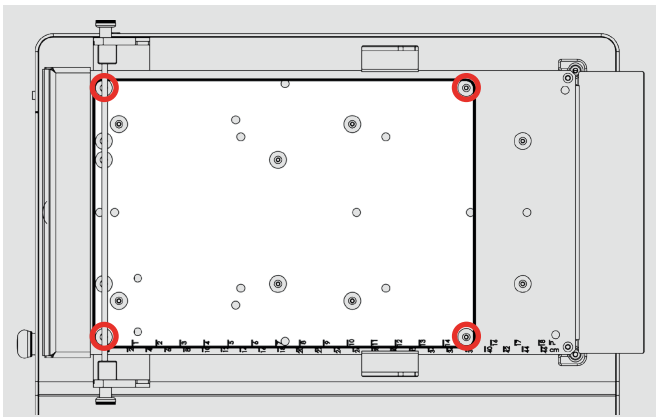

A3

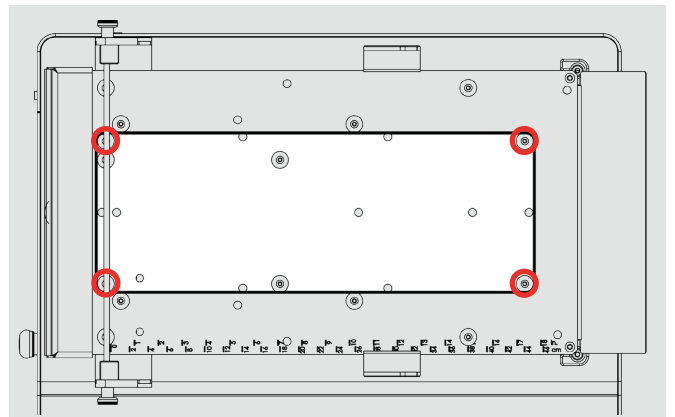

Scrub

### 11.3 Test Chart Placement

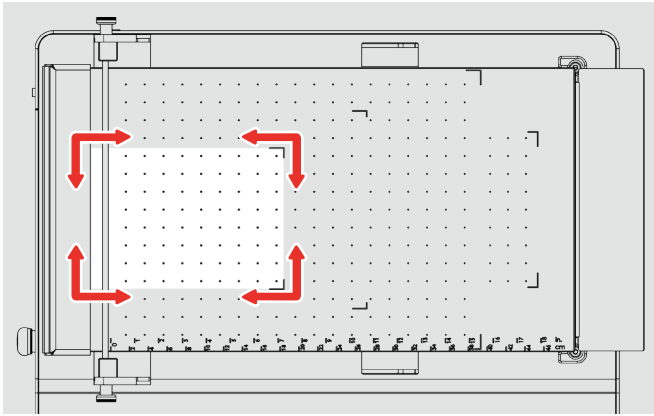

A5

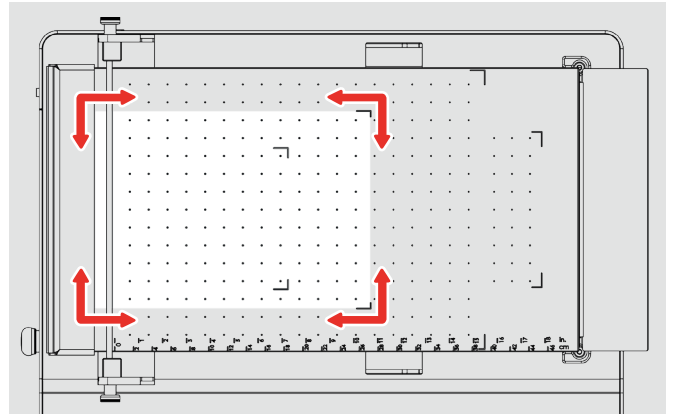

A4

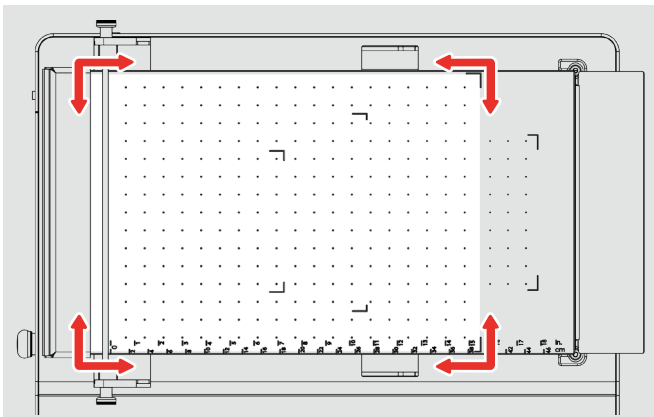

A3

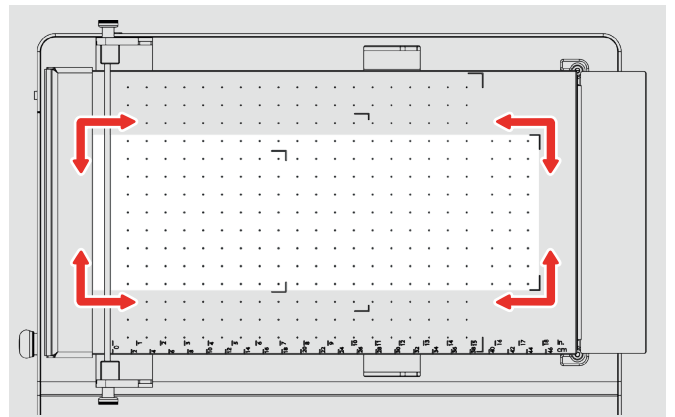

Scrub

### 11.4 Other Chart Sizes

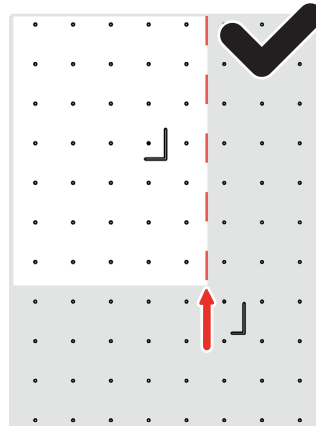
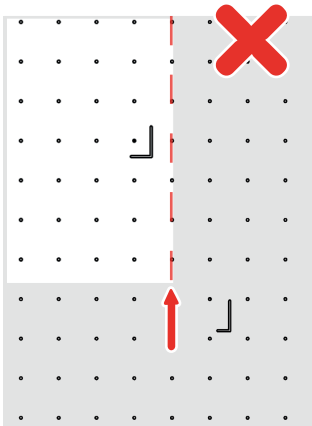

Make sure that the test chart covers the vacuum holes with significant overlap from the edge of the chart to the holes. This to ensure proper vacuum. Improper placement can result in incorrect film build.

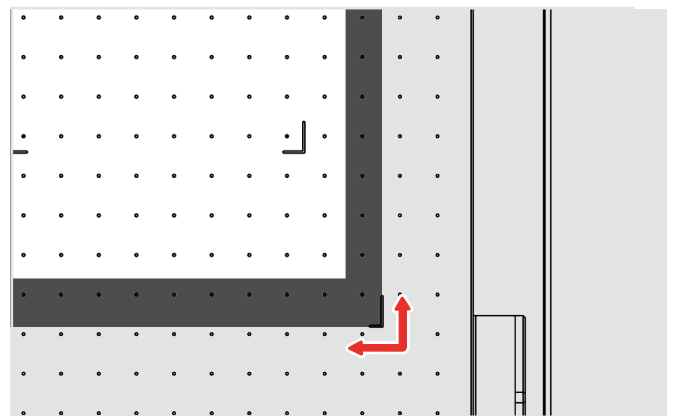

The whole selected vacuum area needs to be covered by cutting a mask in the right size or covering vacuum holes using tape.

## 12 CARE AND MAINTENANCE

- Though robust in design, this instrument is precision-machined. Never drop it or knock it over.
- Always clean the instrument after use.
- Clean the instrument using a soft dry cloth. Never clean the instrument by any mechanical means such as a wire brush or abrasive paper. This may cause, just like the use of aggressive cleaning agents, permanent damage.
- Be careful when using compressed air to clean the instrument.
- When performing maintenance, a signature must be placed in the Maintenance List Annex B.



***Make sure that no paint or other liquids are spilled on the electronics or left in the holes.***

### 10.1 Disposal of Materials

Disposal of materials used in the operation of the instrument or for auxiliary functions and exchanged items should be dealt with safety and in a manner that will not harm the environment. Follow the local regulations.

### 10.2 Customer Service

Customer service is provided on request by

TQC Sheen

Molenbaan 19, 2908LL Capelle aan den IJssel - The Netherlands,

T +31(0)10 7900100, F +31 (0)10 7900129 or by local representatives.

## 13 DISCLAIMER

The right of technical modifications is reserved.

The information given in this manual is not intended to be exhaustive and any person using the product for any purpose other than that specifically recommended in this manual without first obtaining written confirmation from us as to the suitability of the product for the intended purpose does so at his own risk. Whilst we endeavor to ensure that all advice we give about the product (whether in this manual or otherwise) is correct we have no control over either the quality or condition of the product or the many factors affecting the use and application of the product. Therefore, unless we specifically agree in writing to do so, we do not accept any liability whatsoever or howsoever arising for the performance of the product or for any loss or damage (other than death or personal injury resulting from our negligence) arising out of the use of the product. The information contained in this manual is liable to modification from time to time in the light of experience and our policy of continuous product development.

# ANNEX A | OPERATOR QUALIFICATION LIST

Supervisor list (allowed to perform lamp replacement and such).

Date	Name	Signature	Instructed by	Signature

Operator list.

Date	Name	Signature	Instructed by	Signature

# ANNEX B | MAINTENANCE LIST

Date	Action	Name	Signature
	Installed at test location.		
	First run performed.		

